

Power Transmission Solutions

Specialists in chain, gears and couplings



RENOLD
Superior Technology

www.renold.com

Renold products

Unique quality and performance



“ Behind every conceivable industry and application environment; heavy or light duty, indoor or outdoor, clean or contaminated, high or low temperature, Renold is hard at work delivering performance and increasing productivity. ”



Leading edge technology

Renold provides practical cost effective solutions, with a commitment of value through quality. This is achieved by continuous investment in people, process technology and manufacturing.

Consistent reliability

Renold's has more than 125 years of experience in the design and manufacture of power transmission products, to the highest specifications, with proven performance in diverse industries worldwide, which underwrites the guaranteed quality and the assurance of reliability.

Package solutions

One stop for your drive systems, including roller and conveyor chain, gears, motors, couplings, variators and fabricated bases.

Service excellence and care

Renold offers a unique level of service excellence and customer care. Our experienced applications engineers will select the optimum solution with the aid of the latest computer and design technology. Renold is the name for service, care and peace of mind.



Special solutions and innovations

Renold is recognised throughout industry for its ability to create specific solutions to customers' unique requirements. International companies and industries from steel to food processing to escalators to textile machinery have chosen Renold to solve their problems.

Local and international availability

The Renold organisation stretches world-wide.

- More than 20 National Sales Companies
- Nearly 100 Overseas Distributors offering the comprehensive Renold range of power transmission products, directly or through local distributor networks.

Approvals and Quality Assurance

Our manufacturing sites for Chain, Gears and Couplings are certified to ISO 9001:2008. Our roller chain manufacturing sites are certified to ISO 14001:2004.

We are also able to manufacture to the specifications required by API and BAE.

Transmission chain

Solution range overview

Synergy™

Offering unbeatable wear resistance and fatigue performance capabilities, Renold Synergy is designed to maximise productivity and minimise downtime.



Syno™

Renold Syno chain sets a new benchmark for chain performance with little or no lubrication.

The range includes two sintered bush versions and a totally unique, lubricant-free polymer bush version.



Nickel plated

Ensuring extended working life for mildly corrosive environments nickel plated chain made to Renold specifications is specified for applications worldwide.



Stainless steel

Renold Stainless Steel chain is designed for environments where corrosion resistance is paramount.



Hydro-Service™

With a superior corrosion resistant coating, Renold Hydro-Service is an alternative choice to stainless steel.



Specialist chain

Renold's range of roller chain is extensive and the most popular products are featured here.

Renold also offer tailor-made, specialist chain to suit every application.



Standard chain and accessories



Renold

Renold roller chain is highly fatigue resistant, giving up to four times the life of other leading competitor chains.



Renold SD

If you are looking for a good quality product from a reliable supplier for "standard duty" chain applications, look to Renold SD for consistent reliability.



Roll-Ring

The innovative, award-winning Roll-Ring chain tensioner is based on new principles and represents a major advance in chain tensioning technology.



Smartlink

Unique load analysis technology for the detection and diagnosis to ensure smooth running.

Identify problems with alignment and pin-point potential causes of reduced chain life.

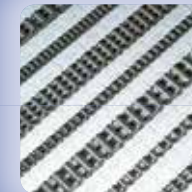

Leaf chain

Renold has more than 100 years experience in the operation and maintenance of lifting chain. Involvement with designers, manufacturers and users of all types of equipment has enabled Renold to develop comprehensive ranges used worldwide for safety-critical lifting applications.

Attachment chain

The most comprehensive range available. Many attachments available from stock with dedicated production facilities to meet customer demands whilst offering extensive experience and flexibility.



Conveyor chain

Range overview



Standard Conveyor Chain

Manufactured to international standards; BS British Standard, STR Steel Thimble Roller to USA designs and ISO to European design.

Within the range are numerous pitch alternatives with breaking loads ranging from 13 to 900 kN as std.

Welded steel and drag chain



There are two main types of chain, Type W for drives and conveyors and Type WD for drag and scraper applications.

Escalator

Manufactured to specific customer designs the range is separated into two categories for light duty retail store use and heavy duty public transport applications.



Customised engineering chain

Covering a wide range of products to suit specialised applications these solutions often using a mix of high specification materials and treatment processes to meet the demands of the particular application.



Agricultural

Produced to ISO/DIN standard and also a range of Works Standard chains used mainly on agricultural harvesting equipment.

The standard range consists of eight chain types with pitches ranging from 1.15 inch (29.21mm) to 2.609 inch (66.27mm).

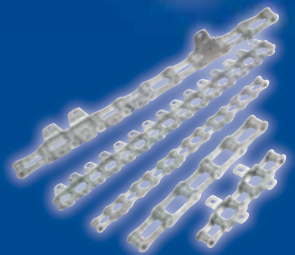

Steel knuckle chain

A USA-designed range of heavy duty, robust, detachable elevator bush chains fitted with integral K type attachments.



Applications



Theme Park

Renold manufacture chains to the highest specification for both water and roller coaster applications. Our chain design developments have exceeded the increasing demands for higher payloads and greater speeds.



Sugar

A wide range of engineered standard and bespoke chains for all applications throughout both cane and beet sugar mills. Renold have considerable experience and expertise in chain design for these arduous applications.



Cement

Renold produce a comprehensive range of Cement mill chain for elevators, apron feeders, reclaim and clinker conveyors, proven in the harsh and abrasive applications of a modern cement mill.

A full inspection and site assessment service is available from our experienced application engineers.



Agriculture

Suppliers to some of the world's largest harvesting OEMs, Renold attention to design, materials and heat treatment results in its range of agricultural chains giving the highest level of performance.

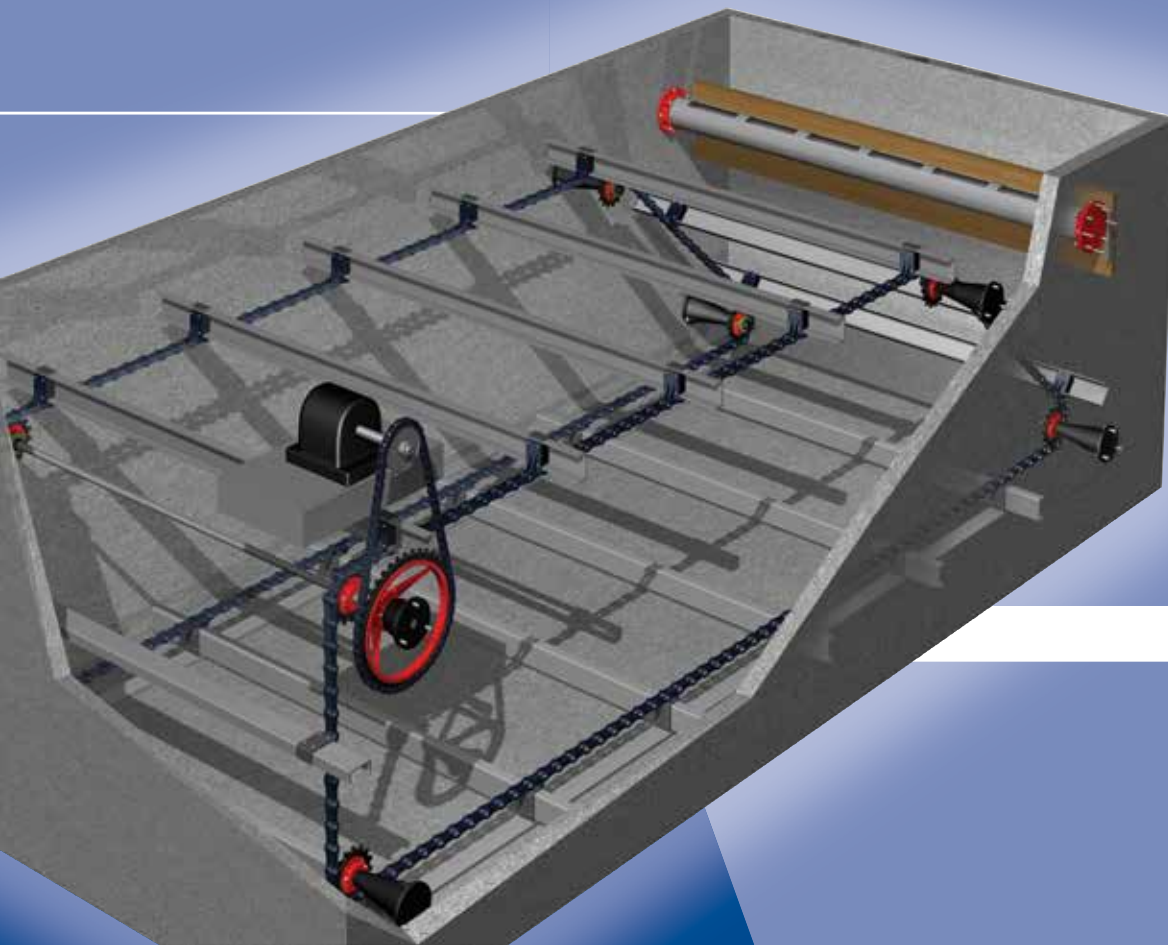

Water Treatment

A full range of products for sewage and water treatment plants manufactured using stainless, and carbon steels or a combination of both with various corrosion protective coatings is available.

Gears & drives

Right angled units

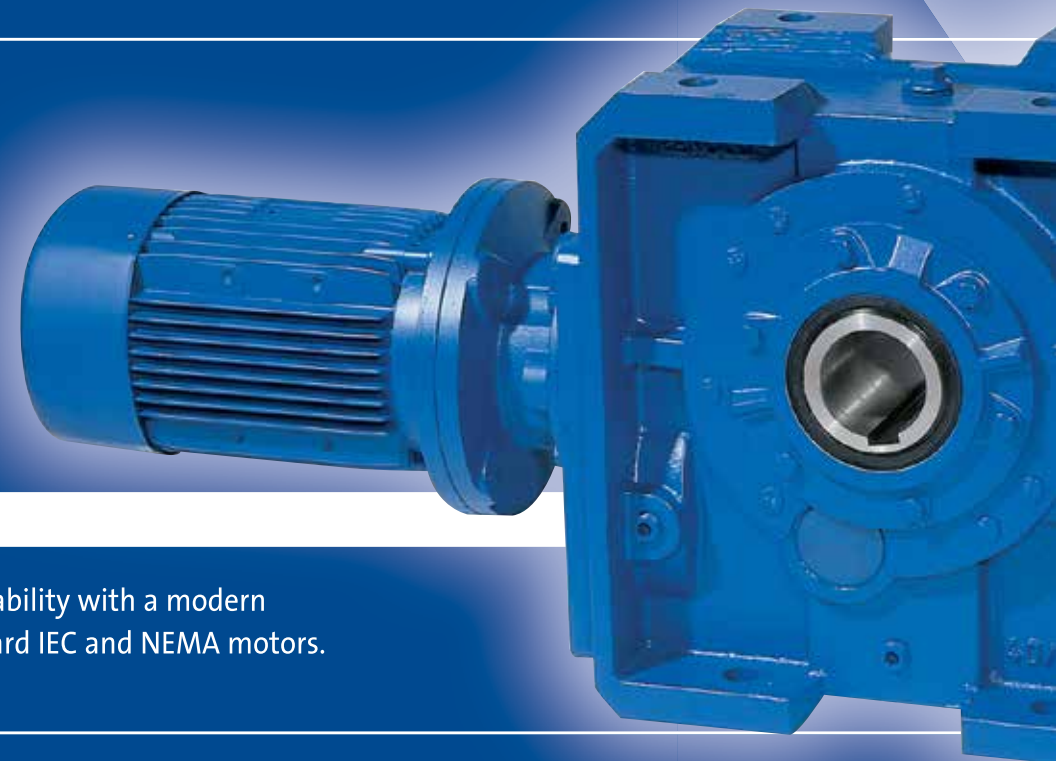

PM Series

The range offers the ultimate in versatility and durability with a modern compact design allowing direct mounting of standard IEC and NEMA motors.

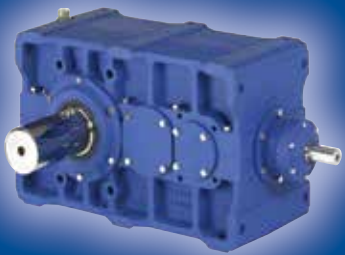

HC series

State of the art heavy duty helical and bevel/helical units using case hardened and ground gears throughout, 14 sizes to 1000KW (1340HP).



TW series

Rugged gear unit for arduous application 10" to 28" (nominal 254mm to 710mm) centre distance available as single and double reduction units with power supply to 1361KW (1824HP).



WM series

WM Series is available with imperial 4" - 9" centres and metric 100mm - 200mm centres, with ratios of 5:1 to 70:1 as a single reduction unit and 75:1 to 4900:1 as a double reduction.

Foot, flange and shaft mounted types available.



jPM

Wormgear units with sizes from 1.125" to 3.0" centre distance, up to 6.66kW capacity.

In-line & variable speed units



RF Series

Shaft mounted helical gear units, available with a direct range mounted motor with ratios up to 300/1 and power capacities up to 7.5kW.



RP Series

In-line helical geared motor and speed reducer units with ratios of up to 363:1 and 22kW capacity.



SMXtra

A range of Shaft Mount Helical Gear Units available with a parallel hollow output shaft, or the unique Renold quick release bush which enables very easy installation and removal of the positive key drive.

Options include integral hold backs, motor mounting platforms and parallel shaft sleeve diameter reducing bushes. Also available are options of input and output shaft enhanced sealing.



Carter gear

Hydrostatic variable speed drive units up to 37KW.

Loose Gears

Worm Gear Sets

Renold is expert in producing high quality bespoke worms and wormwheels to either commercial or precision grades for a wide variety of applications.



Couplings

Industrial Shaft Couplings



Hydrastart Fluid coupling

Fluid soft start couplings available in many sizes and types up to 700KW (950HP) capacity.



Gearflex

Single and double arrangement, standard and heavy duty series types up to 60,000KW (80,000HP) capacity.



Renoldflex

A new range of couplings that utilise a stainless steel spring disc pack to provide a positive 'backlash free' drive, up to 68kW capacity.



Sprag Clutches

Enhanced performance from the optimised, compact sprag design enabling high torque, zero backlash, long life and low maintenance costs.

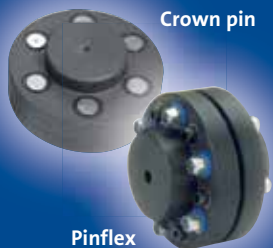

Crown pin

Pinflex

Pin & buffer style

Comprehensive range of shaft couplings including pin and buffer, spider, tyre, disc, chain and gear types available - the widest range from a single source.



Trapped Roller

Available in a number of design types suitable for all backstop, indexing and over-running applications.

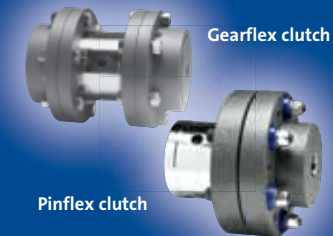

Gearflex clutch

Pinflex clutch

Sprag clutch couplings

Two versions available using Pinflex and Gearflex couplings for total flexibility on shaft-to-shaft transmission drives.

Engineered Couplings

Torsionally flexible and mass transit

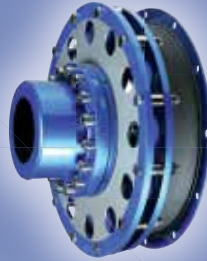

VF couplings

The highly flexible VF coupling has been designed for diesel engines that are mounted separately from the marine gear and which can be placed on flexible mounts.

These flexible mounts provide optimum isolation of the vibrations of the diesel engine from the hull.



RB & PM couplings

Heavy duty industrial couplings providing exceptional protection against severe shock load and vibration.

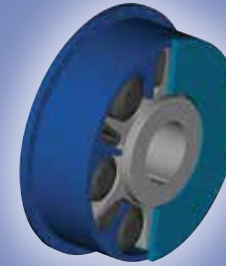

DCB GS

The DCB-GS flexible couplings are designed to couple medium speed diesel and gas engines to alternators, pumps and compressors.



Mass transit couplings

Renold Ajax is the leading North American manufacturer of Traction Couplings for Subway Rail Cars, having produced more than 20,000 units over the past 35 years for use in many cities in the US, Singapore, Malaysia, Brazil, and Korea.



Steel Mill spindles

Renold Ajax is the industry leader in design and manufacturing of custom gear spindles and gear couplings.

Continuing research and development, including finite element analysis and solid modelling design for each customers specification.

For more information or to contact your
local sales team go to **www.renold.com**

UK: +44 (0)161 498 4600
Australia: +61 (0)3 9262 3333
Austria: +43 (0)1 330 3484
Belgium: +32 (0)9 242 95 50
Canada: (800) 265-9970
China: +86 21 5046 2696
Denmark: +45 (0)434 526 11
France: +33 (0)320 16 2929
Germany: +49 (0)5562 810
Hungary: +36 30 228 3269
India: +91 (0)4324 381283
Italy: +39 33584 86971

Malaysia: +60 603-5122 7880
Netherlands: +31 (0)20 614 6661
New Zealand: +64 (0)9 828 5018
Philippines: +63 2 829 6086
Poland: +48 663 84 2487
Romania: +40 726 695652
Russia: +7-495-645-2250
Singapore: +65 6760 2422
South Africa: +27 (0)11 747 9500
Sweden: +45 (0)434 526 11
Switzerland: +41 (0) 44 824 8484
USA: (800) 251-9012



Want to find out more?

Scan this QR code with
your smartphone.

No QR reader? Simply download
one from your app store.

Whilst all reasonable care is taken in compiling
the information contained in this brochure, no
responsibility is accepted for printing errors.

All information contained in this brochure is
subject to change after the date of publication.

© Renold Power Transmission 2013.

Ref: REN5 / ENG / 07.13

RENOLD
Superior Technology